

CHEMGUARD ZF Inductor

Features

- Factory calibrated to any flow and pressure within the working range
- Standard suction height of 11.5 ft (3.5 m) – suction heights up to approximately 20 ft (6 m) available by request
- Standard foam induction rates available with CHEMGUARD C3B or C306-MS 3% AFFF, CHEMGUARD C334-LV 3x3 AR-AFFF, or CHEMGUARD C2 2% High-Expansion foam concentrates – other agents and induction rates available by request
- Can be installed in a horizontal or vertical plane between ANSI Class 150 or DIN PN16 flanges
- Grooved connection and check valve on foam concentrate inlet

Application

The CHEMGUARD ZF Inductor injects foam concentrate into a water stream in a foam system with fixed flow rates. The inductor is designed to handle high back-pressures, extending the allowable distance from the point of foam injection to the point of foam application.

The Inductor can be calibrated for use with many types of foam concentrate, making it suitable for a variety of foam system applications. The inductor is designed to be installed between flanges with a suction line installed to draw foam from an atmospheric foam concentrate tank.

Typical applications include deluge systems with sprinklers or high-expansion generators such as those used in aircraft hangers or storage facilities.

Description

The CHEMGUARD ZF Inductor consists of a bronze body, foam inlet, metering orifice, and recovery horn. The foam inlet has a grooved connection adapter and check valve installed by the manufacturer. The body is labeled to show flow direction and system information such as concentrate type, induction rate, flow rate, and pressure. The orifice is sized by the manufacturer for the specific flow and pressure in which the inductor will be installed.

Standard inductor installations may have suction heights of up to 11.5 ft (3.5 m). Total concentrate piping must not exceed the maximum suction height as a combination of friction loss and elevation head loss from the lowest possible foam concentrate level that can be accessed by the suction line. For suction heights above 11.5 ft (3.5 m), contact Technical Services.

The inductor is installed between two ANSI Class 150 or DIN PN16 flanges. A minimum amount of straight pipe is necessary upstream and downstream of the inductor. See Dimensions J and K under Inductor Dimensions for recommended minimum pipe lengths at each inductor size.



009902

Typical CHEMGUARD Inductor System

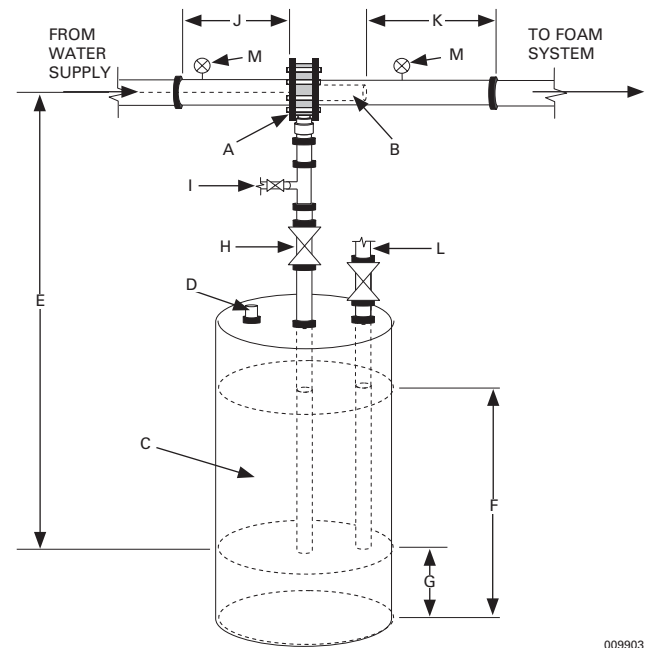

009903

Note: The above drawing is not to scale. For example purposes only.

- A. CHEMGUARD ZF Inductor with check valve installed between flanges
- B. Recovery horn in downstream piping
- C. Foam concentrate storage tank (atmospheric type)
- D. Pressure/vacuum vent
- E. Suction height (Maximum of 11.5 ft (3.5 m) for standard installations)
- F. Foam concentrate level in storage tank
- G. Inaccessible foam concentrate below suction line
- H. Concentrate shut-off valve
- I. Flushing line connection
- J. Minimum straight pipe upstream from the inductor
- K. Minimum straight pipe downstream from the inductor
- L. Fill connection
- M. Inlet and outlet pressure gauges

Calculations

Each CHEMGUARD ZF Inductor is calibrated to the customer-specified system requirements (flow rate and pressure at inductor inlet, foam concentrate type, induction rate, etc.). This information must be provided when ordering.

The required flow of the inductor is dictated by the flow requirement of the discharge devices at the design pressure of the foam system. When determining the pressure for a CHEMGUARD ZF Inductor, two pressure drop calculations must be done:

- On the inductor outlet/system side: from the most remote discharge device to the inductor outlet
- On the inductor inlet/supply side: from the inductor inlet to the fire water supply pump

To help ensure reliable long term function of the system, it is recommended to add a safety margin to the calculation of the pressure loss from the discharge device to the inductor outlet. This accounts for an increase in pressure drop as the system ages. CHEMGUARD recommends using a roughness coefficient of no more than $C=100$ when calculating the pressure losses of the piping system using the Hazen-Williams equation. Consult with the Authority Having Jurisdiction (AHJ) as they may require a more conservative C value based on site conditions.

Example Calculations

Head Loss (Hazen-Williams) Formula:

$$P = \left(\frac{4.52 \times Q^{1.85}}{C^{1.85} \times d^{4.87}} \right)$$

Where:

P = Friction loss (psi/ft)

Q = Flow rate (gpm)

d = Inside pipe measurement (in.)

C = Pipe roughness coefficient

Example:

A high-expansion system with one discharge device requires 295 gpm (1,117 Lpm) at 75 psi (5.2 bar) at the generator inlet with a 2% foam concentrate. The inductor will be connected to the generator with 100 ft (30 m) equivalent length of 3 in. (DN80) Schedule 40 pipe.

The friction loss to the generator is:

$Q = 295$ gpm

$d = 3.068$ in.

$C = 100$

$$P = \left(\frac{4.52 \times 295^{1.85}}{100^{1.85} \times 3.068^{4.87}} \right) \approx 0.14 \text{ psi/ft (0.032 bar/m)}$$

The pressure drop to the generator is:

$0.14 \text{ psi/ft} \times 100 \text{ ft} = 14 \text{ psi (0.97 bar)}$

The designer calculates a pressure loss of 6 psi (0.41 bar) because of elevation changes. The total static demand at the inductor outlet is:

$75 \text{ psi} + 14 \text{ psi} + 6 \text{ psi} = 95 \text{ psi (6.6 bar)}$

The maximum back-pressure at the inductor outlet is 65% of the inlet pressure. The demand at the inductor inlet is:

$95 \text{ psi} \div 65\% = 146 \text{ psi (10.1 bar)}$

The designer also calculates a total pressure loss of 14 psi (0.97 bar) from the fire water pump to the inductor. The pressure requirement of the fire water supply is:

$146 \text{ psi} + 14 \text{ psi} = 160 \text{ psi (11.0 bar)}$

- The fire pump must supply 295 gpm (1,117 Lpm) at 160 psi (11.0 bar)
- A 4 in. CHEMGUARD ZF100 Inductor should be ordered at 295 gpm (1,117 Lpm) and 146 psi (10.1 bar) for use with 2% high-expansion foam concentrate

Installation Requirements

1. The inductor is to be installed between flanges with the recovery horn inserted into the downstream piping.
2. Total concentrate piping must not exceed 11.5 ft (3.5 m) equivalent pipe as a combination of friction loss and elevation head loss from the lowest possible foam concentrate level that can be accessed by the suction line.
3. Downstream pipe, fittings, elevation head, and discharge devices must not result in inductor outlet back-pressure in excess of 65% of inductor inlet pressure. Consult with the system designer to verify.
4. A minimum amount of straight pipe upstream and downstream of the inductor is recommended. See Dimensions J and K under Inductor Dimensions for recommended minimum pipe lengths.
5. A check valve must be installed in the foam concentrate line with the direction of flow from the foam concentrate storage tank to the inductor. The required check valve is installed on the CHEMGUARD ZF Inductor foam concentrate inlet by the manufacturer.
6. A T-fitting and additional valving on the concentrate line to allow flushing after discharge is recommended.
7. The ZF100, ZF150, ZF200, and ZF200S are designed to be installed between two 4 in., 6 in., 8 in., or 8 in. ANSI Class 150 flanges respectively; or between two DN100, DN150, DN200, or DN200 DIN PN16 flanges.
8. Piping to foam concentrate must not be smaller than the concentrate inlet connection. See Dimension B under Inductor Dimensions.

NOTICE

Exceeding foam concentrate line limitations or using pipe sizes smaller than the foam concentrate inlet of the line proportioner, may reduce concentration percentages.

Ordering Information

System requirements (inlet pressure, flow rate, lift height, concentrate name, and induction rate) must be provided at the time of order to properly manufacture the inductor. Standard units must be ordered within the suction height and working range limitations for use with CHEMGUARD C3B or C306-MS 3% AFFF, CHEMGUARD C334-LV 3x3 AR-AFFF, or CHEMGUARD C2 2% High-Expansion foam concentrates. Additional information or manufacturing time may be required for nonstandard installations.

Part No.	Model	Approximate Shipping Weight	
		lb	(kg)
704003	ZF100	25	(11)
704004	ZF150	47	(21)
704005	ZF200	88	(40)
704006	ZF200S	102	(46)

Inductor Dimensions

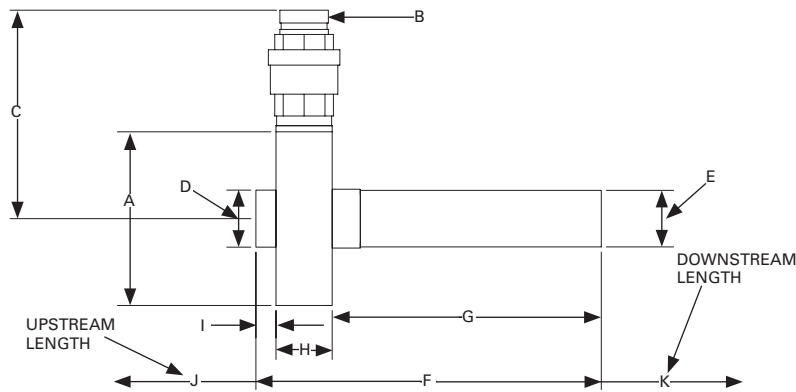

009916

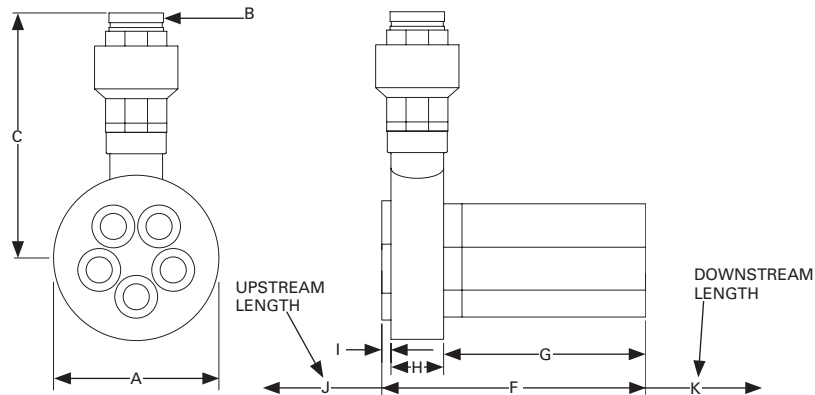

009917

Note: All dimensions are for reference only. Actual units may differ from the example drawings.

Model	A		B ¹		C		D		E		F	
	in.	(mm)	in.	(mm)	in.	(mm)	in.	(mm)	in.	(mm)	in.	(mm)
ZF100	6 5/16	(160)	1 1/2	(38.1)	8 1/2	(215)	2 3/4	(70.0)	2 3/4	(70)	16 9/16	(421)
ZF150	8 7/16	(215)	2	(50.8)	10 3/16	(258)	2 3/4	(70.6)	2 3/4	(70)	16 15/16	(430)
ZF200	10 5/8	(270)	2 1/2	(63.5)	14 7/16	(366)	-	-	-	-	16 15/16	(431)
ZF200S	10 5/8	(270)	3	(76.2)	15 3/4	(400)	-	-	-	-	16 15/16	(431)

Model	G		H ²		I		J ³		K ⁴			
	in.	(mm)	in.	(mm)	in.	(mm)	x Dia	in.	(mm)	x Dia	in.	(mm)
ZF100	13 1/2	(343)	2 5/16	(58)	13/16	(20)	x 5	20	(500)	x 5	20	(500)
ZF150	13 3/16	(335)	2 3/4	(70)	1	(25)	x 5	30	(750)	x 5	30	(750)
ZF200	13	(330)	3 3/8	(86)	9/16	(15)	x 5	40	(1,000)	x 5	40	(1,000)
ZF200S	13	(330)	3 3/8	(86)	9/16	(15)	x 5	40	(1,000)	x 5	40	(1,000)

1 Minimum foam inlet pipe size

2 Take-out (between-the-flange) dimension

3 Minimum recommended straight pipe length upstream of inductor

4 Minimum recommended straight pipe length downstream of inductor from recovery horn

System Specifications

Model	Inductor Size	Minimum Flow Rate		Maximum Flow Rate		Minimum Inlet Pressure		Maximum Inlet Pressure		K-Factor Range	
		gpm (Lpm)	gpm (Lpm)	gpm (Lpm)	gpm (Lpm)	psi (bar)	psi (bar)	psi (bar)	psi (bar)	standard	(metric)
ZF100	4 in. DN100	145 (550)	872 (3,300)	58 (4)	232 (16)	19-57	(275-1,000)				
ZF150	6 in. DN150	290 (1,100)	1,744 (6,600)	58 (4)	232 (16)	38-114	(550-2,000)				
ZF200	8 in. DN200	435 (1,650)	2,615 (9,900)	58 (4)	232 (16)	57-172	(825-3,000)				
ZF200S	8 in. DN200	762 (2,750)	4,359 (16,500)	58 (4)	232 (16)	95-286	(1,375-5,000)				

Working range of ZF100

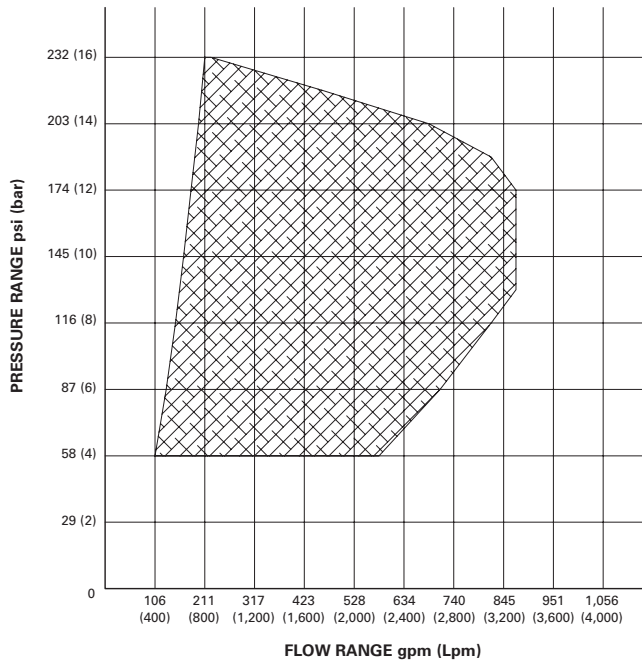

009922

Working range of ZF150

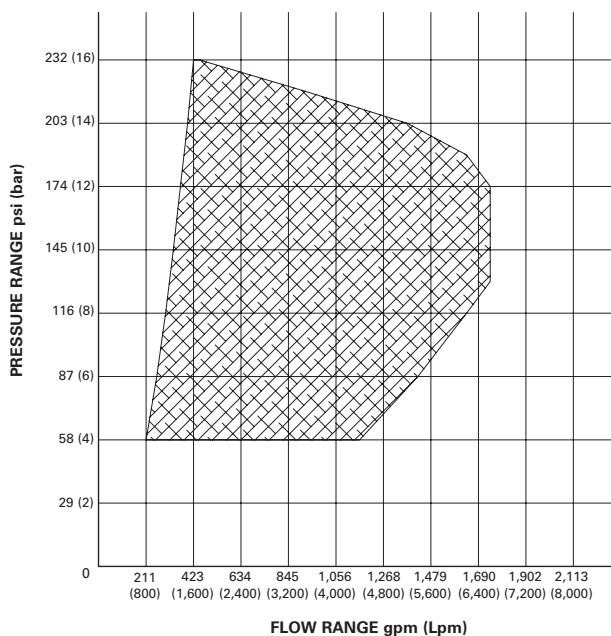

009923

Working range of ZF200

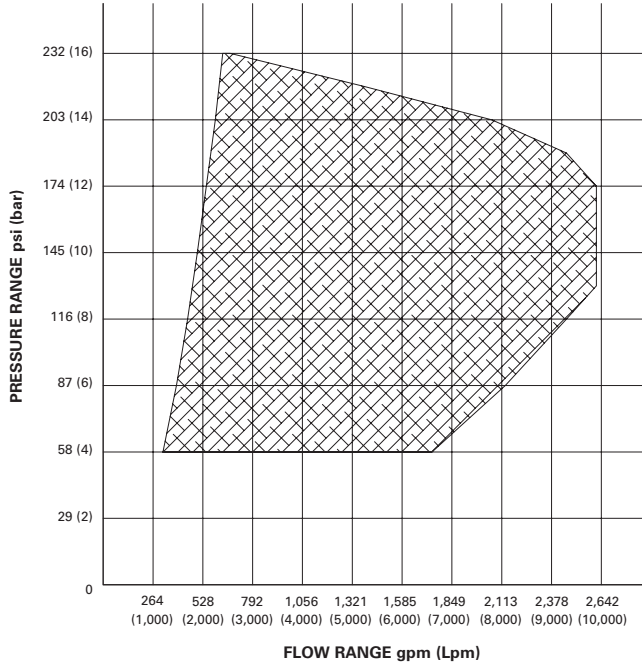

009924

Working range of ZF200S

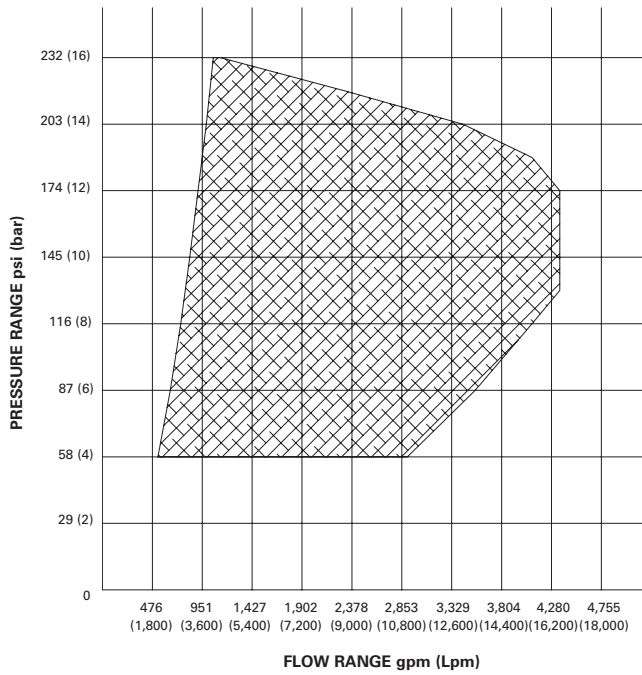

009925

Note: The converted values provided in this document are for nominal reference only and do not reflect an actual measurement. CHEMGUARD and the product names listed in this material are marks and/or registered marks. Unauthorized use is strictly prohibited.

